











Superior[™]
FIREPLACES
Our name is our promise.

TRADITIONAL

The DVF Series direct vent gas fireplaces are a traditional design for a true masonry-built appearance, and offer an expansive glass opening for an exceptional view of the tall, dancing flames. The DVF Series provides endless possibilities for making your living area warm and inviting.

EXCLUSIVE FEATURES

-  Available in 36" and 42" models
-  Conveniently located gas controls for easy installation and operation
-  Clean-face design allows more flexibility for a custom look
-  Multi-level burner produces tall, dancing flames with beautiful embers
-  Energy saving electronic controls with seamless battery backup provide continued operation in the event of a power outage
-  Tall opening provides an exceptional view of the flame
-  Ceramic fiber log set with cast-iron metal grate
-  Detailed refractory panels available in multiple styles and colors
-  Optional, easy to install matching perimeter trim hides the glass door frame to achieve a true masonry appearance
-  Includes on/off remote control
-  20 year limited warranty

INCLUDED ACCESSORY



Remote

APPLIANCE SPECIFICATIONS

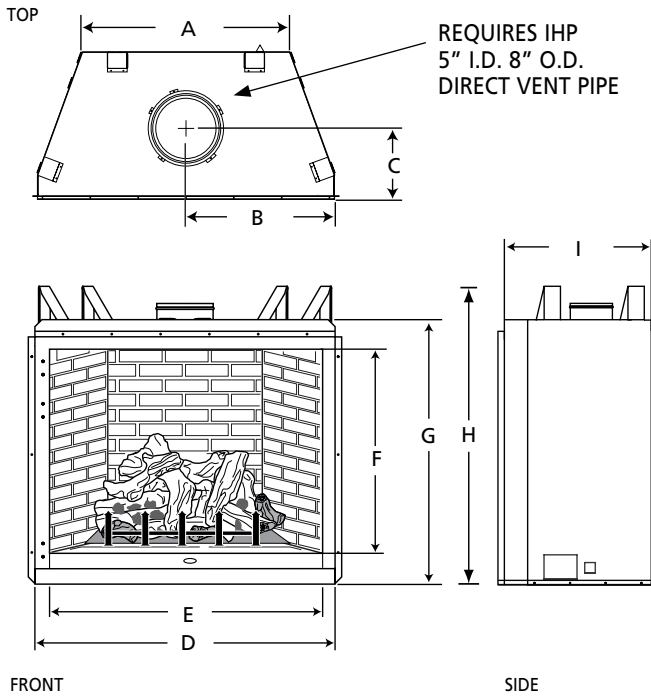

| | DVF 36 | DVF 42 |
|---|---------|---------|
| A | 29-1/8" | 34-3/4" |
| B | 20-1/2" | 24-1/8" |
| C | 11-7/8" | 13-5/8" |
| D | 41" | 48" |
| E | 35" | 42" |
| F | 30-7/8" | 34-7/8" |
| G | 38-7/8" | 42-7/8" |
| H | 43" | 47" |
| I | 21-1/8" | 25-1/8" |

FIREPLACE EFFICIENCIES

| MODEL | FUEL | BTU/HR | P4 / ENERGUIDE* |
|--------|------|--------|-----------------|
| DVF 36 | NG | 33,500 | 34.35% |
| DVF 36 | LP | 31,000 | 32.45% |
| DVF 42 | NG | 41,000 | 24.67% |
| DVF 42 | LP | 37,000 | 22.79% |

*Intermittent ignition systems

IMPORTANT NOTES:

As with any fireplace, this appliance is extremely hot during operation. Read and understand all operating instructions before using this appliance. For further information, consult your dealer.

Local conditions, such as elevation, wind, vent configuration and choice of fuel will affect overall appearance of the fire and heating performance. Performance can also vary with home design and insulation, climate, condition and type of fuel used, appliance location, burn rate, accessories chosen, chimney installation and how the appliance is operated.

Diagrams, illustrations and photographs are not to scale—consult installation instructions. Product designs, materials, dimensions, specifications, colors and prices are subject to change or discontinuance without notice.

INTERIOR OPTIONS

Choose from four realistic refractory panel designs.



White Split Herringbone



White Split Stacked



Red Split Herringbone



Red Split Stacked

Choose from two realistic Perimeter Trim Kits to add the finishing touch to your new fireplace.



Red Split Stacked Perimeter Trim Kit



White Split Stacked



Red Split Stacked

FLAT WALL FRAMING SPECIFICATIONS

| | DVF 36 | DVF 42 |
|--------|---------|---------|
| HEIGHT | 44" | 48" |
| WIDTH | 41-1/2" | 48-1/2" |
| DEPTH | 22" | 26" |

On the cover: DVF 36 shown with Red Herringbone Refractory Panels and Red Perimeter Trim Kit.



Approved for use with European Copper and Chimney Classics chimney tops, which improve performance and add an elegant touch.



© Innovative Hearth Products 2014

785574M 08/14



Visit us online



SuperiorFireplaces.us.com

