

BRT2032 | BRT2332 | BRT2532

 MERIT SERIES B-VENT FIREPLACES

Superior[™]
FIREPLACES
Our name is our promise.



TRADITIONAL

This decorative fireplace is the perfect choice for smaller spaces or rooms where the simple beauty of a fireplace is one of the primary goals.



FEATURED BRT2532 with White Stacked refractory brick and Aged Oak log set.

EXCLUSIVE FEATURES

- 🔥 Radiant (louverless) design delivers a clean, traditional look that is quick and easy to install with a fan option
- 🔥 Aged Oak logs create the look of real wood
- 🔥 Tall active flames with a glowing ember bed
- 🔥 Access gas controls through either lower face panel or inside refractory floor
- 🔥 Positive lock outside air mechanism
- 🔥 Interior selection consists of painted black or refractory panels
- 🔥 Available in either electronic or millivolt ignition system
- 🔥 BRT20 uses 4" b-vent, BRT23/25 uses 5" b-vent
- 🔥 Optional Remote Control for added convenience



FEATURED BRT2532 with White Stacked refractory brick and Aged Oak log set.

INTERIOR LINER OPTIONS

(Required)



All Black interior *

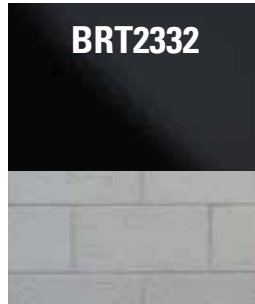

White Stacked Hearth w/
Black back and side panels

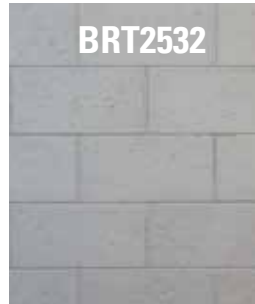

All White Stacked interior

EXTERIOR OPTIONS

(Optional)

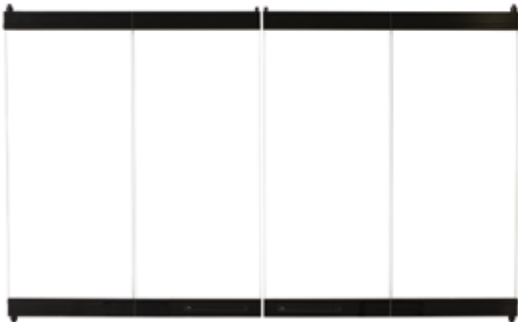

Bi-Fold Glass Doors



Black



Brass



Platinum

* Example of this combination may be seen on the front cover.

FLAT WALL FRAMING SPECIFICATIONS

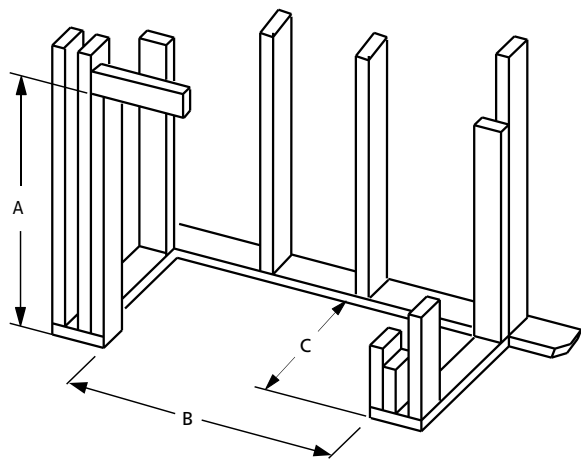

	BRT2032	BRT2332	BRT2532
A	36-5/8"	36-5/8"	36-5/8"
B	34-3/4"	34-3/4"	34-3/4"
C	16-1/8"	16-1/8"	16-1/8"

CORNER FRAMING SPECIFICATIONS

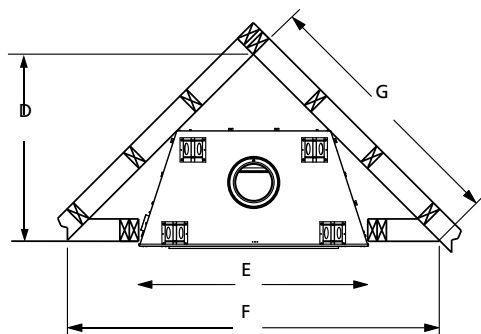

	BRT2032	BRT2332	BRT2532
D	32-3/4"	32-3/4"	32-3/4"
E	55-5/8"	55-5/8"	55-5/8"
F	34-1/2"	34-1/2"	34-1/2"
G	39-3/8"	39-3/8"	39-3/8"

IMPORTANT NOTES:

As with any heating appliance, fireplace or stove, this appliance is extremely hot during operation. Read and understand all operating instructions before using this appliance. For further information, consult your dealer. Local conditions, such as elevation, wind, vent configuration and choice of fuel will affect overall appearance of the fire and heating performance. Performance can also vary with home design and insulation, climate, condition and type of fuel used, appliance location, burn rate, accessories chosen, chimney installation and how the appliance is operated.

Diagrams, illustrations and photographs are not to scale—consult installation instructions. Product designs, materials, dimensions, specifications, colors and prices are subject to change or discontinuance without notice.

APPLIANCE SPECIFICATIONS

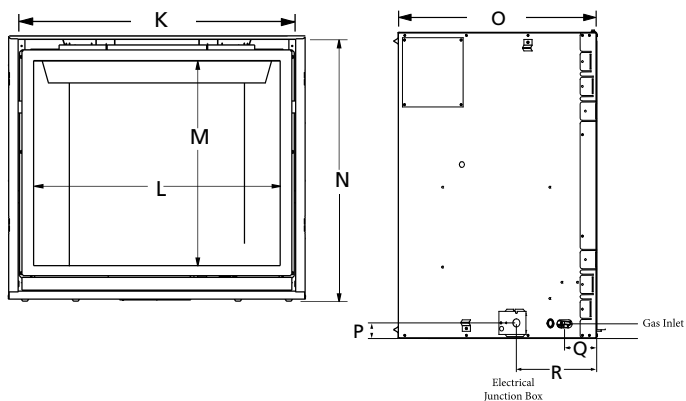
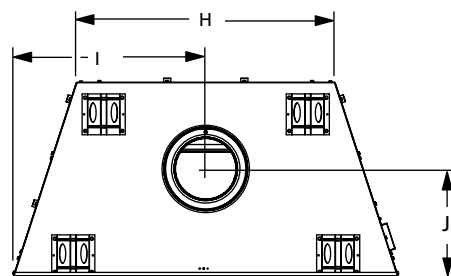

	BRT2032	BRT2332	BRT2532
H	22-3/8"	22-3/8"	22-3/8"
I	17-1/4"	17-1/4"	17-1/4"
J	11-3/4"	11-3/4"	11-3/4"
K	35-3/8"	35-3/8"	35-3/8"
L	29-1/2"	29-1/2"	29-1/2"
M	18-1/4"	18-1/4"	18-1/4"
N	25-1/4"	25-1/4"	25-1/4"
O	16-3/4"	16-3/4"	16-3/4"
P	2-1/2"	2-1/2"	2-1/2"
Q	7-5/8"	7-5/8"	7-5/8"
R	10-5/8"	10-5/8"	10-5/8"

FIREPLACE EFFICIENCIES

MODEL	FUEL	BTU/HR
BRT2032	NG	15,000
BRT2332	NG	25,000
BRT2532	NG	25,000



© 2014 Innovative Hearth Products

785380M 01/14

Visit us online



www.SuperiorFireplaces.us.com

