

**TRUE**  
DIRECT VENT GAS FIREPLACE

**HEAT & GLO**



Available IntelliFire®  
app and voice control



TRADITIONAL TO CONTEMPORARY  
**DESIGN AT ITS BEST**



# TRUE

---

The best fire. The distinct look. The largest view. It is TRUE.  
The most authentic masonry appearance gas fireplace is here.

---

## BIG IMPACT

Your home is a reflection of your personal style and a fireplace with the largest view in their class command attention. From streamlined edges and finishing touches the TRUE has styling to match your interior.

## BOLD FIRES

Enjoy the ambiance of your fireplace with or without the fire. Vivid flames rise to life through an illuminated ember bed with LED accent lighting. Your fireplace is the backdrop of life's memorable moments, encouraging you to enjoy the ambiance of the fireplace with or without the fire. Vivid flames rise to life through an illuminated ember bed with LED accent lighting.

## DISTINCTIVE DETAILS

We have turned up the detail for the most desirable authentic appearance in a gas fireplace. Complete your style with high definition logs, glowing embers and your choice of brick or fade resistant reflective black glass interior panels. Enjoy the view with virtually invisible anti-reflective glass and the IntelliFire Touch® remote, for simple, smart and safe control.

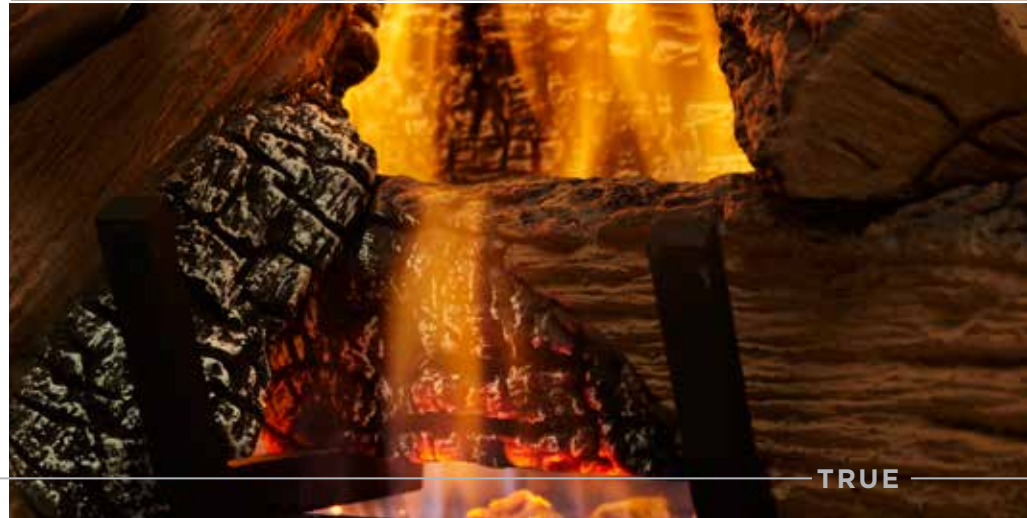

LEFT: TRUE shown with firescreen front in black and traditional brick interior

TRUE



*TRUE shown with firescreen front in black and fade-resistant reflective black glass interior*



*TRUE shown with chateau forge front and herringbone brick interior in tranquil greige*

## MODELS AVAILABLE

Three models. And the right size for your space.



**TRUE 36** Shown with firescreen front in new bronze and stratford interior.



**TRUE 42** Shown with firescreen front in black and fade-resistant black glass interior.



**TRUE 50** Shown with firescreen arch front in new bronze and herringbone interior.

| FEATURES                         | TRUE 36                                                                                 | TRUE 42                                                                                 | TRUE 50                                     |
|----------------------------------|-----------------------------------------------------------------------------------------|-----------------------------------------------------------------------------------------|---------------------------------------------|
| Fireplace Width                  | 36"                                                                                     | 42"                                                                                     | 50"                                         |
| Room Size Fit                    | Medium                                                                                  | Medium to large                                                                         | Large                                       |
| BTU/hr Input                     | 28,000 to 45,500                                                                        | 30,500 to 55,500                                                                        | 36,000 to 65,000                            |
| Interior Panel Options           | Traditional or herringbone brick panels or fade-resistant reflective black glass panels | Traditional or herringbone brick panels or fade-resistant reflective black glass panels | Traditional or herringbone brick panels     |
| IntelliFire® App & Voice Control | Optional IntelliFire Wi-Fi Module                                                       | Optional IntelliFire Wi-Fi Module                                                       | Optional IntelliFire Wi-Fi Module           |
| IntelliFire Touch Remote Control | Standard                                                                                | Standard                                                                                | Standard                                    |
| Wall Switch                      | Optional                                                                                | Optional                                                                                | Optional                                    |
| Logs                             | Seven high-definition logs                                                              | Eight high-definition logs                                                              | Nine high-definition logs                   |
| Embers                           | LED illuminated embers                                                                  | LED illuminated embers                                                                  | LED illuminated embers                      |
| Accent Lighting                  | LED accent lighting                                                                     | LED accent lighting                                                                     | LED accent lighting                         |
| Glass                            | Virtually invisible anti-reflective ceramic                                             | Virtually invisible anti-reflective ceramic                                             | Virtually invisible anti-reflective ceramic |
| Ignition System                  | IntelliFire Touch                                                                       | IntelliFire Touch                                                                       | IntelliFire Touch                           |
| Flame Turndown                   | 50%                                                                                     | 50%                                                                                     | 50%                                         |

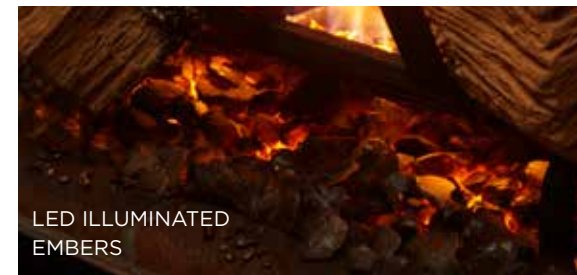

## FRONT OPTIONS

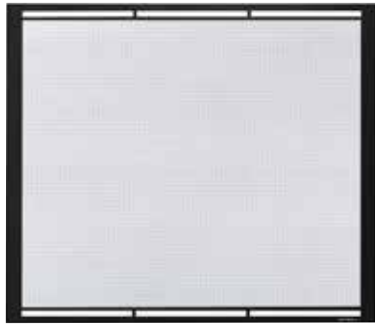

### FIRESCREEN

Available in black, new bronze or graphite.

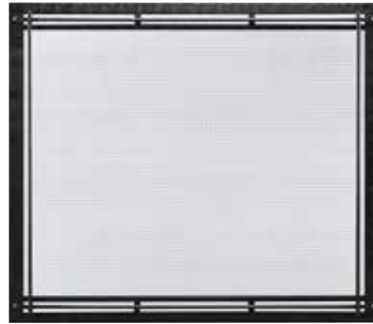

### FORGE

Available in hand-crafted, hammered steel.



### FIRESCREEN ARCH

Available in black, new bronze or graphite. *Requires Arch Kit.*

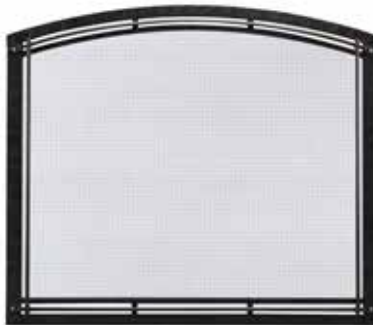

### FORGE ARCH

Available in hand-crafted, hammered steel. *Requires Arch Kit.*

## FINISHES

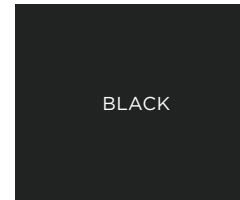

BLACK

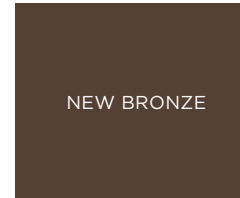

NEW BRONZE



GRAPHITE

## INTERIOR PANEL OPTIONS

Interior panels add intricate detail and enhance the fireside appearance.



TRANQUIL GREIGE  
HERRINGBONE BRICK



STRATFORD  
TRADITIONAL BRICK

## TRUE TECHNOLOGIES



### INTELLIFIRE TOUCH IGNITION SYSTEM

IntelliFire Touch is our most advanced intermittent-pilot ignition (IPI) system, making operating your appliance simple, smart and safe. Select the IntelliFire app, touchscreen remote control or wireless wall switch for the solution that fits your lifestyle.



### ANTI-REFLECTIVE GLASS

A cleaner, more distinct view of the fire. A glare reduction of 89% over standard ceramic glass, making it virtually invisible. And an experience so real, friends may just try and add a log to the fire.

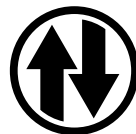

### DIRECT VENT TECHNOLOGY

Direct Vent fireplaces remove 100% of combustion exhaust and odors outside of the home. These sealed fireplaces provide optimal heat, conserve energy and ensure clean, safe indoor air quality.

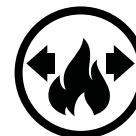

### HEAT MANAGEMENT SOLUTIONS

Bring the warmth from your fireplace to the rest of your home, up to 20 feet away. Heat management technology can redirect up to 50% of the heat to another area, also reducing wall temperatures above the fireplace. Choose between a **Heat-Zone**® kit to transfer heat where you want it, or a **Heat-Out**® kit to draw heat from your fireplace and direct it outside, up to 25 feet away. When run continuously on high, it can redirect up to 40% of the heat off the fireplace, also reducing wall temperatures above the fireplace.



FADE RESISTANT REFLECTIVE  
BLACK GLASS

## CONTROLS

### INTELLIFIRE APP

All the features of a remote control with an app installed on your smart device. Monitor your fire from anywhere or even control it with the sound of your voice. IntelliFire is compatible with voice assistants Amazon Alexa and Google Assistant.



### TOUCHSCREEN REMOTE

Features: on/off, flame height adjustment, fan speed, lights adjustment, thermostat mode, room temperature readout, child lock, timer mode, battery backup, cold climate mode, power vent, wall docking station (fan, lights and power vent are dependent on your fireplace).



### WIRELESS WALL SWITCH

Features: on/off, battery strength indicator, cold climate mode



## MANTEL SHELVES

A mantel shelf is the perfect accent to a fireplace and a place to showcase some of your most cherished mementos. Available in 48, 59 or 72-inch lengths in a variety of finish options.



GIFFORD



OZARK



FILLMORE



### LED ACCENT LIGHTING

Superior performance and extended efficiency. This technology provides high-contrast, brilliant lighting to accentuate the flames. Can be used as mood lighting, with or without the flames.



### LED EMBER BED

Add an extra layer of dimension and light to your fire. Realistic illuminated LED embers let you enjoy the ambiance, with or without the fire.

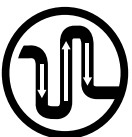

### POWER VENT TECHNOLOGY

Fireplaces aren't just for exterior walls. A fan-powered accessory with slim venting can zigzag throughout your home—up, down, over or under – making it possible to install a gas fireplace virtually anywhere.



### FADE-RESISTANT BLACK GLASS PANELS

A distinctly modern look that subtly reflects the fire and never gets dull for the life of your fireplace.

# TRUE SPECIFICATIONS

| MODEL   | FRONT WIDTH |                 | BACK WIDTH      |                 | HEIGHT         |            | DEPTH     |           | GLASS SIZE                       | BTU/HOUR INPUT (NG) |
|---------|-------------|-----------------|-----------------|-----------------|----------------|------------|-----------|-----------|----------------------------------|---------------------|
|         | UNIT        | FRAMING         | UNIT            | FRAMING         | UNIT           | FRAMING    | UNIT      | FRAMING   |                                  |                     |
| TRUE-36 | 61" [1549]  | 59-1/2" [1511]  | 59-1/4" [1505]  | 59-1/2" [1511]  | 57-5/8" [1464] | 56" [1422] | 24" [610] | 24" [610] | 35-7/8" x 31-1/16" [911 x 789]   | 28,000 - 45,500     |
| TRUE-42 | 67" [1702]  | 65-9/16" [1665] | 65-5/16" [1659] | 65-9/16" [1665] | 62-5/8" [1591] | 61" [1549] | 24" [610] | 24" [610] | 41-7/8" x 36-1/16" [1064 x 916]  | 30,500 - 55,500     |
| TRUE-50 | 75" [1905]  | 73-9/16" [1869] | 73-5/16" [1862] | 73-9/16" [1869] | 66-5/8" [1692] | 65" [1651] | 24" [610] | 24" [610] | 49-7/8" x 40-1/16" [1267 x 1018] | 36,000 - 65,000     |

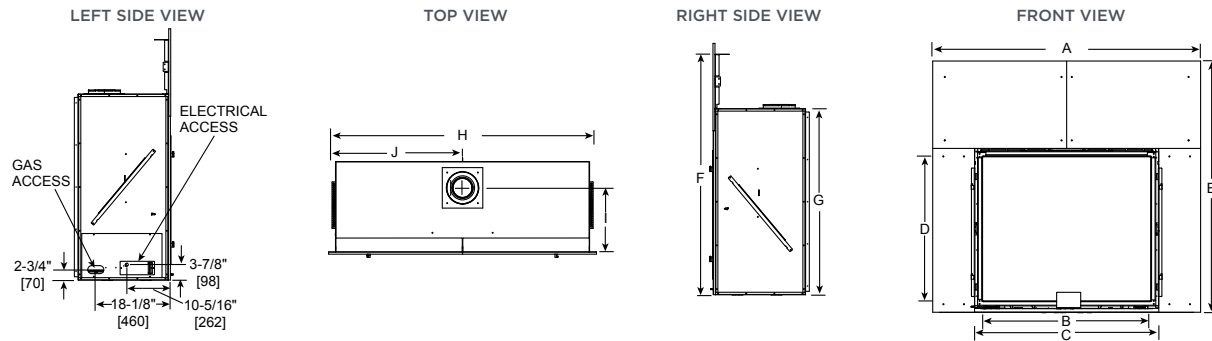

| Model   | A          | B              | C              | D               | E              | F                | G              | H               | I         | J               |
|---------|------------|----------------|----------------|-----------------|----------------|------------------|----------------|-----------------|-----------|-----------------|
| TRUE-36 | 61" [1549] | 35-7/8" [911]  | 39-7/8" [1013] | 31-1/16" [789]  | 57-5/8" [1464] | 54-15/16" [1395] | 41-3/8" [1042] | 59-1/4" [1505]  | 16" [406] | 29-5/8" [752]   |
| TRUE-42 | 67" [1702] | 41-7/8" [1064] | 45-7/8" [1165] | 36-1/16" [916]  | 62-5/8" [1591] | 59-15/16" [1522] | 46-3/8" [1178] | 65-5/16" [1659] | 16" [406] | 32-11/16" [830] |
| TRUE-50 | 75" [1905] | 49-7/8" [1267] | 53-7/8" [1368] | 40-1/16" [1018] | 66-5/8" [1692] | 63-15/16" [1624] | 50-3/8" [1280] | 73-5/16" [1862] | 16" [406] | 36-11/16" [932] |

\*Front dimensions include non-combustible material which overlaps framing

Dimensions are in inches and millimeters. Product information is not complete and is subject to change without notice. Product installation must adhere strictly to instructions shipped with product. We recommend measuring individual units at installation. Assumes the use of 1/2" sheetrock. NOTE: Combustible material should not cover the face. Make sure you do NOT cover the decorative door opening.

Refer to installation manual for detailed specifications on installing this product. Heat & Glo® reserves the right to update units periodically. The flame and ember appearance may vary based on the type of fuel burned and the venting configuration used. Actual product appearance, including flame, may differ from product images.

## CANADA EFFICIENCIES

**EnerGuide (CSA P.4.1-15)** - EnerGuide is a rating used in Canada to measure annual fireplace efficiency.

| TRUE-36                | TRUE-42                | TRUE-50                |
|------------------------|------------------------|------------------------|
| 57.6% (NG), 57.1% (LP) | 67.0% (NG), 68.4% (LP) | 69.1% (NG), 66.5% (LP) |

For complete information on this model, please contact us at:

# HEAT & GLO®

No one builds a better fire

- Web: [heatnglo.com](http://heatnglo.com)
- Phone: (888) 427-3973
- E-mail: [info@heatnglo.com](mailto:info@heatnglo.com)
- [facebook.com/HeatandGlo](https://www.facebook.com/HeatandGlo)
- [twitter.com/HeatandGlo](https://twitter.com/HeatandGlo)
- [youtube.com/HeatandGlo](https://www.youtube.com/HeatandGlo)

## LIMITED LIFETIME WARRANTY\*

The strongest in the industry, Heat & Glo® provides a limited lifetime warranty on the most important aspects: firebox and heat exchanger.

\*For full warranty details, go to [www.heatnglo.com](http://www.heatnglo.com).

Fireplace glass and other surfaces get extremely HOT and can cause severe burns if touched. Do not remove the protective safety screen from the front of the glass. Keep a safe distance away. To learn more visit [www.heatnglo.com/fireplacesafety](http://www.heatnglo.com/fireplacesafety)

Google, YouTube and Google Home are trademarks of Google LLC. Amazon, Alexa, and all related logos are trademarks of Amazon.com, Inc. or its affiliates.

HNG-1119U-0420

