

— & —
TRUE

DIRECT VENT GAS FIREPLACES

— HEAT & GLO —



TRADITIONAL STYLE
AT ITS BEST

TRUE

The best fire. The cleanest look. The largest view. It is TRUE.
The most authentic masonry appearance available is here.

BIG IMPACT

The largest viewing areas in their class command attention. Crisp edges and tight finishing completes the clean look.

BOLD FIRES

Vivid flames rise to life through an illuminated ember bed with LED accent lighting. Enjoy the ambiance with or without the fire.

DISTINCTIVE DETAILS

For the most authentic appearance, we turned up the detail. High definition logs. Glowing embers. Textured interior panels. Witness it all through anti-reflective glass



LEFT: TRUE 42 shown with forge front and herringbone interior

COVER: TRUE 36 shown with castlewood interior



*TRUE 36 shown with firescreen in
new bronze and stratford interior*

MODELS AVAILABLE

Three models. And the right size for your space.



TRUE 36
Shown with firescreen in new bronze and stratford interior.



TRUE 42
Shown with forge front and castlewood interior.



TRUE 50
Shown with firescreen arch in new bronze and herringbone interior.

FRONT OPTIONS

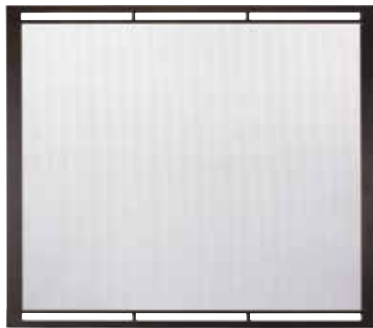

FIRESCREEN
Available in black, new bronze or graphite finishes.

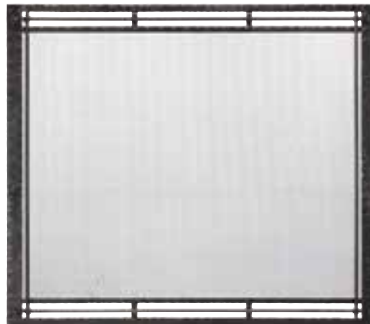

FORGE
Available in hand-crafted, hammered steel.



FIRESCREEN ARCH
Available in black, new bronze or graphite finishes.



FORGE ARCH
Available in hand-crafted, hammered steel.

FINISHES

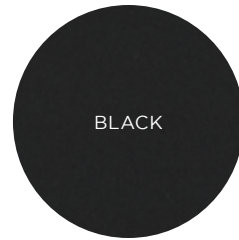

INTERIOR OPTIONS

Textured brick interiors add intricate detail and a traditional masonry appearance. Standard on all TRUE models.



STRATFORD



HERRINGBONE



CASTLEWOOD

TRUE TECHNOLOGIES



INTELLIFIRE PLUS IGNITION SYSTEM

An advanced intermittent pilot ignition system with memory settings and a programmable wireless RC300 remote control. IPI Plus constantly monitors ignition, ensures safe functioning and conserves up to \$10/month in energy costs.

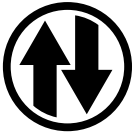

DIRECT VENT TECHNOLOGY

Direct Vent fireplaces remove 100% of combustion exhaust and odors outside of the home. These sealed fireplaces provide optimal heat, conserve energy and ensure clean, safe indoor air quality.



ANTI-REFLECTIVE GLASS

A cleaner, more distinct view of the fire. A glare reduction of 89% over standard ceramic glass. And an experience so real, friends may just try and add a log to the fire.

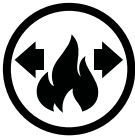

HEAT ZONE TECHNOLOGY

Draw heat from your fireplace into another room of the home, up to 20 feet away. When a heat zone kit is run continuously, it will redirect up to 25% of the fireplace's heat to another area, thus reducing wall temperatures above the fireplace. Two heat zones run continuously will redirect up to 50% of the fireplace's heat.



TRUE SPECIFICATIONS

MODEL	FRONT WIDTH		BACK WIDTH		HEIGHT		DEPTH		GLASS SIZE	BTU/HOUR INPUT (NG)
	UNIT	FRAMING	UNIT	FRAMING	UNIT	FRAMING	UNIT	FRAMING		
TRUE-36	61 [1549]	59-1/2 [1511]	59-1/4 [1505]	59-1/2 [1511]	57-5/8 [1464]	56 [1422]	24 [610]	24 [610]	35-7/8 x 31-1/16 [911 x 789]	28,000 - 45,000
TRUE-42	67 [1702]	65-9/16 [1665]	65-5/16 [1659]	65-9/16 [1665]	62-5/8 [1591]	61 [1549]	24 [610]	24 [610]	41-7/8 x 36-1/16 [1064 x 916]	30,000 - 55,000
TRUE-50	75 [1905]	73-5/8 [1870]	73-5/16 [1862]	73-5/8 [1870]	66-5/8 [1692]	65 [1651]	24 [610]	24 [610]	49-7/8 x 40-1/16 [1267 x 1018]	37,000 - 65,000

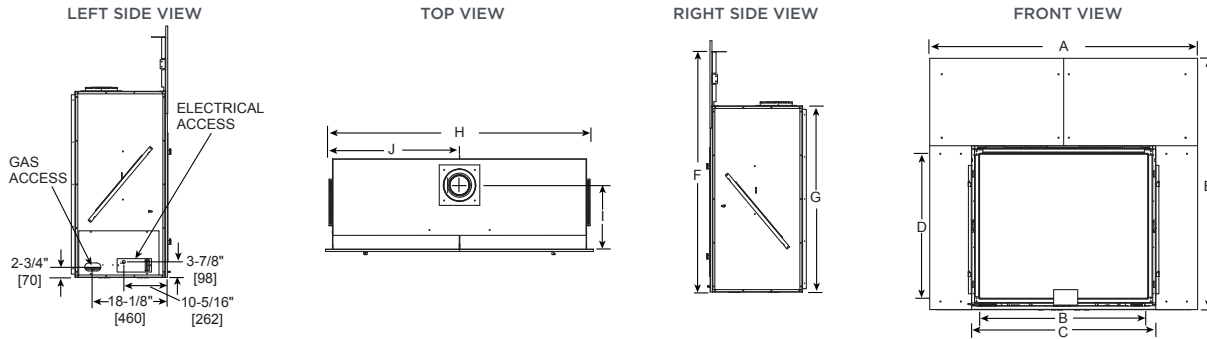

Model	A	B	C	D	E	F	G	H	I	J
TRUE-36	61" [1549]	35-7/8" [911]	39-7/8" [1013]	31-1/16" [789]	57-5/8" [1464]	54-15/16" [1395]	41-3/8" [1042]	59-1/4" [1505]	16" [406]	29-5/8" [752]
TRUE-42	67" [1702]	41-7/8" [1064]	45-7/8" [1165]	36-1/16" [916]	62-5/8" [1591]	59-15/16" [1522]	46-3/8" [1178]	65-5/16" [1659]	16" [406]	32-11/16" [830]
TRUE-50	75" [1905]	49-7/8" [1267]	53-7/8" [1368]	40-1/16" [1018]	66-5/8" [1692]	63-15/16" [1624]	50-3/8" [1280]	73-5/16" [1862]	16" [406]	36-11/16" [932]

*Front dimensions include non-combustible material which overlaps framing

Dimensions are in inches and millimeters. Product information is not complete and is subject to change without notice. Product installation must adhere strictly to instructions shipped with product. We recommend measuring individual units at installation. Assumes the use of 1/2" sheetrock. NOTE: Combustible material should not cover the face. Make sure you do NOT cover the decorative door opening.

Refer to installation manual for detailed specifications on installing this product. Heat & Glo® reserves the right to update units periodically. The flame and ember appearance may vary based on the type of fuel burned and the venting configuration used. Actual product appearance, including flame, may differ from product images.

U.S. EFFICIENCIES

Steady State - Since most homeowners use their fireplaces for an extended time while they are in the room, Steady State measures how efficiently your fireplace converts fuel to heat once it is warmed up and running in a "steady state".

AFUE - AFUE rating is more typically used with appliances, like your furnace, that continually cycle on and off to maintain a constant temperature.

RATING	TRUE-36	TRUE-42	TRUE-50
STEADY STATE	76.2% (NG), 76.2% (LP)	77.2% (NG), 77.2% (LP)	68.9% (NG), 67.3% (LP)
AFUE	51.9% (NG), 55.3% (LP)	67.0% (NG), 67.6% (LP)	66.8% (NG), 65.2% (LP)

CANADA EFFICIENCIES

EnerGuide (CSA P.4.1-02) - EnerGuide is a rating used in Canada to measure annual fireplace efficiency.

RATING	TRUE-36	TRUE-42	TRUE-50
ENERGUIDE (CSA P.4.1-02)	57.6% (NG), 57.1% (LP)	67.0% (NG), 68.4% (LP)	69.1% (NG), 66.5% (LP)

For complete information on this model,
please contact us at:

HEAT & GLO

No one builds a better fire

Web: heatnglo.com
Phone: (888) 427-3973 (952) 985-6000
E-mail: info@heatnglo.com

 facebook.com/HeatandGlo

 twitter.com/HeatandGlo

 youtube.com/HeatandGlo

HNG-1119U-1114

LIMITED LIFETIME WARRANTY*

The strongest in the industry, Heat & Glo® provides a limited lifetime warranty on the most important aspects: firebox and heat exchanger.

*For full warranty details, go to www.heatnglo.com.

Fireplace glass and other surfaces get extremely HOT and can cause severe burns if touched. Do not remove the protective safety screen from the front of the glass. Keep a safe distance away. To learn more visit www.heatnglo.com/fireplacesafety

